

AUX

USER MANUAL



C-Smart

OPERATION AND MAINTENANCE

SERVICE AND INSTALLATION

Due to the continuous development of its products, the manufacturer reserves the right to introduce changes to the products and technical documentation for the devices.

Please read this manual carefully before operating the device.
Keep this user manual throughout the entire service life of the device to refer to it whenever necessary.

Table of Contents

Operation and Maintenance

Warning	4
Safety Precautions	5
User Information	12
Names of Individual Components	14
Cleaning and Maintenance	15
Troubleshooting	17

Service and Installation

Installation Notes	19
Installation of the Indoor Unit	25
Installation of the Outdoor Unit	28
Post-installation Verification	31
Maintenance Guidelines	32







Note: All illustrations in this manual are for explanatory purposes only.
The actual appearance of the device may differ from the illustrations.

Warning

Warning: This air conditioner contains the flammable refrigerant R32.

Notes: The air conditioner with R32 refrigerant, if damaged or improperly used, can cause serious harm to the body or surrounding objects.

- The space for the installation, operation, maintenance, and storage of this air conditioner should be greater than 5m².
- The refrigerant charge should not exceed 1.7 kg.
- Do not use any methods to accelerate defrosting or cleaning of frosted parts, except those specifically recommended by the manufacturer.
- Do not puncture the refrigerant pipes or use open flames near the air conditioner, and ensure that the refrigerant pipes are not damaged.
- The air conditioner should be stored in a room without a permanent open ignition source, such as an open flame from a gas appliance or an operating electric heater.
- Note that the refrigerant may be odorless.
- The air conditioner should be stored in a way that prevents mechanical damage due to accidents.
- Maintenance or repair of air conditioners with R32 refrigerant must be carried out after a safety check to minimize the risk of accidents.
- The air conditioner must be installed with a shutoff valve cover.
- Read the instruction manual carefully before installation, operation, and maintenance.

SYMBOL	NOTE	EXPLANATION
	WARNING	This symbol indicates that the appliance uses a flammable refrigerant. If the appliance is leaked and exposed to an external ignition source, there is a risk of fire. (Only for air conditioners with UL or ETL-MARKING, UL60335-2-40)
	WARNING	This symbol indicates that the appliance uses a flammable refrigerant. If the appliance is leaked and exposed to an external ignition source, there is a risk of fire. (Only for air conditioners with CE-MARKING and CB-MARKING, IEC 60335-2-40+A1:2016)
	WARNING	This symbol indicates that the appliance uses a material with low burning velocity. (Only for air conditioners with CB-MARKING, IEC 60335-2-40:2018)
	INFORMATION	This symbol shows that the user manual should be carefully read.
	INFORMATION	This symbol indicates that the service personnel should handle the equipment according to the installation manual.
	INFORMATION	This symbol shows that information is available in the user manual or installation manual.

Safety Precautions

Incorrect installation or operation due to failure to follow this instruction may cause injury, damage to the body, objects, etc. The significance of the markings is classified according to the following indications:

WARNING !

This symbol indicates the possibility of death or serious injury.

CAUTION !

This symbol indicates the possibility of injury or property damage.

WARNING !

This appliance can be used and operated by children aged 8 years and above and by persons with reduced physical, sensory, or mental capabilities or lack of experience and knowledge, provided they are supervised by an adult who has understood and is familiar with the device's operating instructions and understands the associated hazards. Children should not play with the appliance. Cleaning and maintenance should not be performed by children without supervision. (For AC units with the CE marking only)

This appliance is not intended for use by persons (including children) with reduced physical, sensory, or mental capabilities, or who lack appropriate experience and knowledge, unless they have been given supervision or instruction concerning the safe use of the appliance by a person responsible for their safety. Children should be supervised to ensure that they do not play with the appliance. (Except for AC units with the CE marking)

Safety Precautions

1. The air conditioner must be grounded. Improper grounding may result in electric shock. Do not connect the grounding wire to the gas pipeline, water pipeline, lightning rod, or telephone earth wire.
2. If the unit is not used for an extended period of time, it should be turned off and the power supply disconnected.
3. Take care to ensure that the indoor unit and the remote control are not exposed to moisture or wet conditions. Contact with water may cause a short circuit.
4. A damaged power cord must be replaced immediately by the manufacturer, an authorized service technician, or a qualified person. A faulty power cord may result in electric shock.
5. Do not turn off the main power switch during operation. Touching the unit with wet or damp hands may result in electric shock.
6. The power outlet must not be shared with other electrical devices. Otherwise, this could cause electric shock, or even fire and explosion.
7. The device must always be turned off and the power supply disconnected before cleaning or performing any maintenance work.
8. It is forbidden to pull on the power cable. Damage caused by pulling the power cable can lead to serious electric shock.
9. The drains connected to the unit should not contain any ignition sources.
10. The air conditioner must not be installed near flammable gas or liquid. The distance from the unit to sources of flammable gas or liquid must be at least 1 meter. Failure to follow these safety guidelines may result in fire or explosion.
11. Do not use liquids or corrosive cleaning agents to wipe the air conditioner. Spraying water or other liquids on the device is prohibited. This may cause a risk of electric shock or even damage the unit.
12. Repair attempts must only be carried out by an authorized service technician or a qualified person. Self-repairs by the user are prohibited and may cause damage to the unit, fire, or explosion.
13. The air conditioner must not be used during thunderstorms. The power supply should be disconnected in time to prevent potential hazards and damage to the unit.
14. Do not insert hands or any objects into the air intake or outlet openings of the unit. This could cause personal injury and damage to the unit.
15. Ensure that the mounting plate is correctly installed and stable. A damaged or improperly secured mounting plate may cause the unit to fall, resulting in damage or injury.
16. Do not block the air intake or outlet. Otherwise, this may weaken the cooling or heating capability and even cause the unit to stop working.
17. It is forbidden to position the air conditioner so that it blows air directly onto another heating device. This may cause incomplete combustion and lead to poisoning.
18. To avoid potential electric shock, a residual current device with the appropriate rated capacity must be installed.
19. The unit should be installed in accordance with national electrical installation regulations.

Safety Precautions

The air conditioner must be grounded. Incomplete grounding can result in electric shock. Do not connect the grounding wire to a gas pipe, water pipe, lightning rod, or the grounding wire of a telephone line.



Always turn off the unit and disconnect the power when it will not be used for an extended period to ensure safety.



Be careful not to spill water on the remote control or the indoor unit, or make them too damp. Otherwise, this could cause a short circuit.



If the power cord is damaged, it must be replaced by the Manufacturer, Authorized Representative, or an electrician.



Do not disconnect the main power switch while the unit is operating or with wet hands. This may result in electric shock!



Do not share the power outlet with other electrical devices. Otherwise, this may cause electric shock, fire, or explosion.

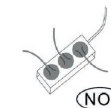

Always turn off the unit and disconnect the power before performing any maintenance or cleaning. Otherwise, this could cause electric shock or damage.



Do not pull on the power cord. Damage caused by pulling the power cord can lead to serious electric shock.



Warning: The wires connected to the unit must not contain any ignition sources.

Safety Precautions

Do not install the air conditioner in an area with flammable gas or liquid. The distance between them should exceed 1 meter. This may cause a fire due to an explosion.

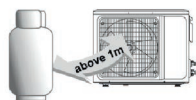

Do not use liquid or corrosive cleaners to clean the air conditioner, and do not pour water or any other liquids on it. This could cause electric shock or damage the device.

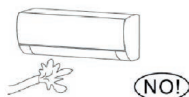

Do not attempt to repair the air conditioner yourself. Improper repairs may cause fire or explosion. Contact a service technician for all required maintenance checks.



Do not use the air conditioner during a thunderstorm. The power should be disconnected in a timely manner to prevent any hazards.

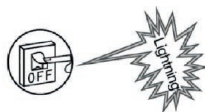

Do not insert hands or any objects into the air inlet or outlet. This could cause injury or damage to the device.



Ensure that the installed brackets are sufficiently strong. If they are damaged, they may cause the unit to fall, resulting in injury.

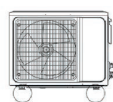

Do not block the air inlet or outlet. Otherwise, the cooling or heating efficiency will be reduced, and the system may stop functioning.



Do not allow the air conditioner to blow air directly onto a heating device. This may lead to incomplete combustion, causing poisoning.



The device should be installed in accordance with national wiring regulations. To prevent possible electric shocks, a residual current device (RCD) should be installed.

Safety Precautions

This product contains fluorinated greenhouse gases.

A refrigerant leak contributes to climate change. A refrigerant with a lower global warming potential (GWP) would contribute less to global warming than a refrigerant with a higher GWP if it were to leak into the atmosphere. This device contains a refrigerant with a GWP of [675].

This means that if 1 kg of this refrigerant were to leak into the atmosphere, its impact on global warming would be [675] times greater than 1 kg of CO₂ over 100 years.

Never attempt to interfere with the refrigerant circuit or disassemble the product yourself. Always call a technician with the proper qualifications.

Ensure that the following items are not near the indoor unit:

1. Microwave ovens, stoves, and other hot objects.
2. Computers and other devices with high static electricity.
3. Electrical distribution panels, which are often used to connect devices.

The connecting fittings between the indoor and outdoor units should not be reused unless the pipe has been re-soldered.

The fuse specification is printed on the printed circuit board, for example: 3.15 A / 250 V AC, etc.

WARNING WEEE

Meaning of the crossed-out trash bin symbol:

Do not dispose of electrical devices as unsorted municipal waste; use separate collection points. Contact local authorities for information on available collection systems.

If electrical devices are disposed of in landfills, hazardous substances may leak into groundwater and enter the food chain, harming your health and well-being. When replacing old devices with new ones, the seller is legally required to take back the old device for disposal free of charge.



Safety Precautions

Do not open windows or doors while the air conditioner is running. Otherwise, the cooling or heating performance may be weakened.



Do not stand on top of the outdoor unit or place heavy objects on it. This weight could cause injury or damage to the unit.

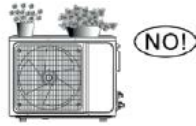

Do not use the air conditioner for purposes such as drying clothes, preserving food, etc.



Do not direct cold air at your body for long periods. This could worsen your physical condition and cause health issues.



Set the appropriate temperature. Proper temperature regulation can prevent the waste of electricity.



If your air conditioner is not equipped with a power cord and plug, install an explosion-proof switch in the appropriate circuit of the electrical installation, and the distance between the contact points should not be less than 3.0 mm.

If your air conditioner is permanently connected to a separate electrical circuit, a residual current device (RCD) with a rated residual operating current not exceeding 30 mA should be installed in the appropriate circuit of the electrical installation.

The power circuit of the air conditioner should be equipped with both residual current protection and a circuit breaker of type C, with a capacity greater than 1.5 times the maximum current.

Information regarding the installation of the air conditioner can be found in the following sections of this manual.

User Information

Conditions under which the unit may not operate normally

Within the temperature range given in the table below, the air conditioner may stop functioning and other anomalies may occur.

Cooling	Outdoor	>43 °C (It applies to T1)
	Indoor	>52 °C (It applies to T3)
Heating	Outdoor	<18 °C
	Indoor	>24 °C <-25 °C >27 °C

When the temperature is too high, the air conditioner may activate an automatic protective device to safely turn off the unit. When the temperature is too low, the air conditioner's heat exchanger may freeze, causing water dripping or other abnormal behavior.

During prolonged cooling or dehumidification with relative humidity above 80% (when doors and windows are open), condensation may occur near the air outlet, or water may drip.

T1 and T3 refer to the ISO 5151 standard.

Heating notes

- The indoor unit fan will not start immediately after heating is turned on to avoid blowing cold air.
- When it is cold and wet outside, the outdoor unit may frost on the heat exchanger as the heating power increases. The air conditioner will then activate the defrosting function.
- During defrosting, the air conditioner stops heating for about 5-12 minutes.
- During defrosting, steam may come out of the outdoor unit. This is not a malfunction, but a result of rapid defrosting.
- Heating will resume once the defrosting process is complete.

Shut-down notes

- When the air conditioner is turned off, the main controller will automatically decide whether to stop immediately or to operate for a few seconds at a lower frequency and lower air speed before shutting down.

User Information

Emergency mode

- If the remote control is lost or damaged, use the emergency start button to operate the air conditioner.
- If the button is pressed while the unit is off, the air conditioner will operate in automatic mode.
- If the button is pressed while the unit is on, the air conditioner will stop working.

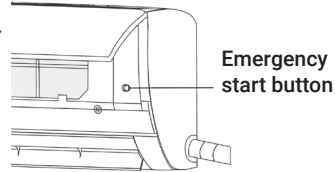

Airflow direction adjustment

- Use the up-down and left-right louver movement buttons on the remote control to adjust the airflow direction. Detailed information can be found in the remote control manual.
- For models without left-right louver functionality, adjust them manually before turning on the unit.

Note: Moving the louvers during operation can cause finger injury. Never insert your hand into the air intake or outlet when the air conditioner is running.

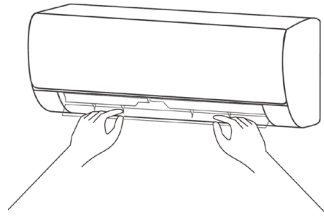

Special precautions

- Open the front panel of the indoor unit.
- The connector (as shown in the diagram) should not touch the terminal board and must be positioned as shown in the diagram.

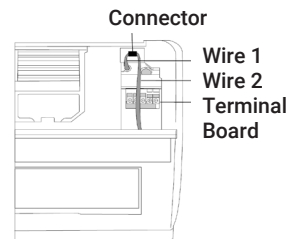

Names of Individual Components

Indoor unit

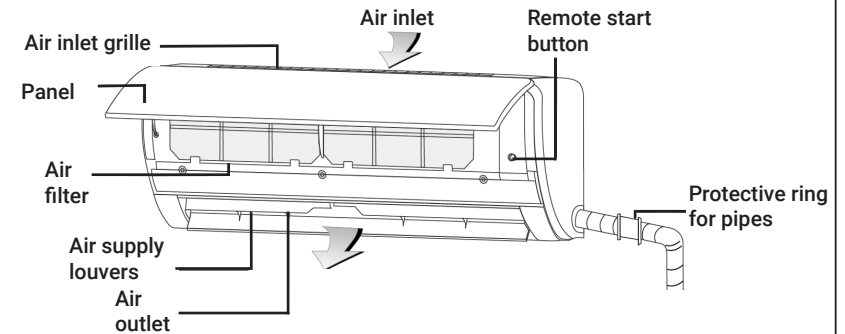

Outdoor unit

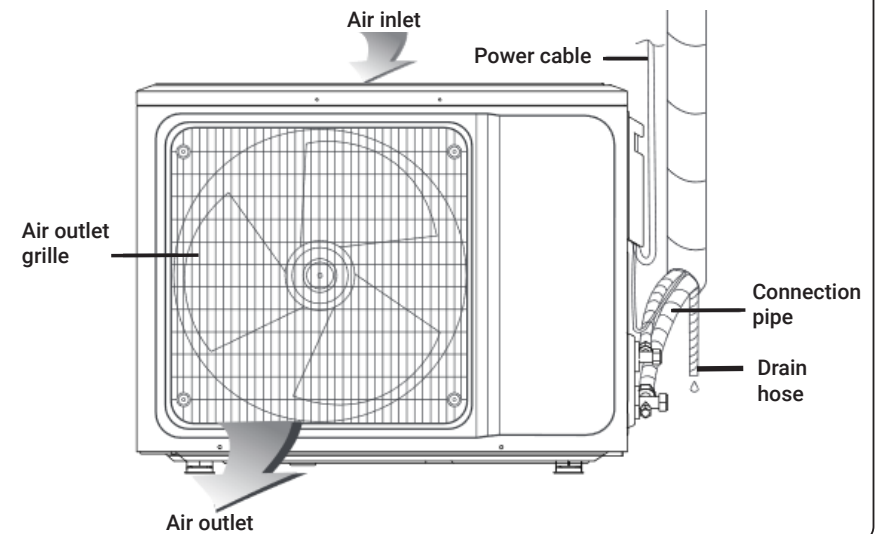

Note: All illustrations in this manual are for reference only. The actual appearance of the unit may vary. The connection diagram depends on the air conditioner model.

Cleaning and Maintenance

WARNING !

- Before cleaning the air conditioner, turn it off, and the power supply must be disconnected at least 5 minutes earlier to avoid the risk of electric shock.
- Do not spray water on the indoor unit of the air conditioner, as this may result in electric shock. Ensure that under no circumstances will the unit get wet.
- Volatile liquids such as thinner or gasoline may damage the air conditioner's casing, so clean the casing only with a soft dry cloth and a damp cloth soaked in a neutral detergent.
- During use, regularly clean the filter to prevent dust accumulation, which may affect the cooling/heating efficiency. If the environment where the air conditioner is used is particularly dusty, increase the frequency of maintenance and cleaning. When removing the filter, do not touch the internal fins or apply excessive force that could damage the refrigerant piping.

Cleaning the panel

When the panel of the indoor unit is dirty, gently clean it with a wrung towel using lukewarm water below 40°C, and do not remove the panel while cleaning.

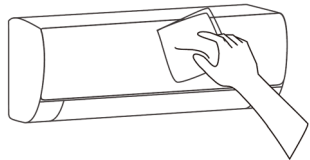

Cleaning the air filter

Remove the air filter

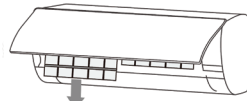
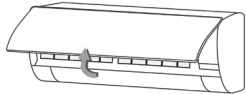

1. Use both hands to open the panel at an angle from both ends, following the direction of the arrow.
2. Release the air filter from its slot and remove it.

Clean the air filter

Use a vacuum cleaner or rinse the filter with water. If the filter is very dirty (e.g., with greasy stains), wash it with warm water (below 45°C) and a mild detergent dissolved in water. Then, place the filter in a shaded area to dry.



Cleaning and Maintenance

Install the filter

Reinstall the dried filter in the reverse order of removal, then close and snap the panel catches.

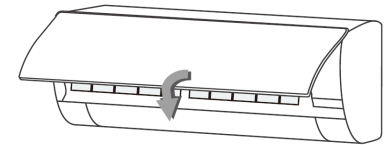
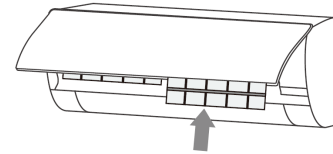

Pre-season check

- Ensure that all air inlets and outlets in the units are not blocked.
- Check that there are no blockages at the drainage pipe outlet, and clean immediately if there is.
- Verify that the grounding wire is securely fastened.
- Check if the remote control batteries are installed and that the charge level is sufficient.

Post-season maintenance

- Disconnect the power supply to the air conditioner, turn off the main power switch, and remove the batteries from the remote control.
- Clean the filter and the unit's housing.
- Remove dust and debris from the outdoor unit.
- Check for any damage to the mounting brackets of the outdoor unit, and if found, contact our local service center.

Troubleshooting

CAUTION !

Do not attempt to repair the air conditioner yourself, as improper maintenance may result in electric shock, fire, or explosion. Contact the automated service center. Please check the following items before contacting the service center, as this may save you time and money.

Problem	Troubleshooting
Air conditioner is not working	Power supply interruptions may occur -> Wait for the power to return. The plug may be loose in the socket -> Securely insert the plug. The fuse may have blown -> Replace the fuse. The timer countdown is still ongoing -> Wait or cancel the timer settings.
The air conditioner does not start immediately after being restarted.	If the air conditioner is turned on immediately after being switched off using the on-off button, the safety switch will delay the start operation by 3 to 5 minutes.
The air conditioner stops working shortly after starting.	It may have reached the set temperature -> This is a normal phenomenon. It may be in defrost mode -> Operation will automatically resume and restart after defrosting. The timer turn-off time may be set -> If you still wish to use it, turn it on again.
There is airflow from the air conditioner, but the cooling/heating effect is unsatisfactory.	Excessive dust accumulation on the filter, blockage of airflow at the intake and exhaust, and incorrect angle of the air louvers will all affect the cooling and heating performance. -> Clean the filter, remove obstructions from the intake and exhaust, and adjust the angle of the air intake louvers. Poor cooling and heating is caused by open doors and windows or an unused exhaust fan. -> Please close the doors, windows, and turn off the exhaust fan. The additional electric heating function is not turned on during heating, which may lead to poor heating performance. -> Turn on the additional electric heating function (only available in models equipped with this function). The operation mode setting is incorrect, and the temperature and airflow settings are not appropriate. -> Re-select the operation mode and set the correct temperature and airflow speed.
The indoor unit is emitting an unpleasant odor.	The air conditioner itself does not emit any undesirable odors. If there is an odor, it may result from the accumulation of smells in the surroundings. -> Clean the air filter or activate the cleaning function.

Troubleshooting

When turning on the air conditioner, a water-splashing sound is heard.

When the air conditioner is turned on or off, or the compressor starts or stops during operation, a „hissing“ water-splashing sound may sometimes be heard. -> This is the sound of refrigerant flow and not a malfunction.

A faint „click“ sound is heard when turning on or off.

Due to temperature changes, the panel and other parts will expand and contract, causing a friction sound. -> This is a normal phenomenon and not a defect.

The indoor unit is making an unusual sound.

The sound of the fan or compressor relay turning on and off.
The sound when defrosting begins or ends. -> This is due to the refrigerant flow in the opposite direction. These are not malfunctions.
Excessive dust in the air filter of the indoor unit may cause noise. -> Clean the air filters from time to time.
Excessive noise when the „strong wind“ air supply speed is activated. -> This is a normal phenomenon. If it feels uncomfortable, turn off the turbo air supply with increased performance.

Water droplets appear on the surface of the indoor unit.

When the surrounding humidity is high, water droplets may accumulate around the air outlet or panel, etc. -> This is a normal physical phenomenon. Prolonged cooling in an open space may cause water droplets to form. -> Close doors and windows.
An excessively small angle of the air louver opening can also cause water droplets at the air inlet. -> Increase the air louver angle setting.

During cooling operation, mist may occasionally be blown out of the indoor unit's air outlet.

When the temperature and humidity in the room are high, this situation may occur. -> This happens because the air in the room is cooled quite quickly. After some time, the internal temperature and humidity will decrease, and the mist will disappear.

If any of the following situations occur, immediately stop all operations, disconnect the power, and contact local service.

A sharp sound is heard or you smell a terrible odor during operation.
There is improper heating of the power cord and plug.
The unit or remote controller is contaminated or exposed to water.
The residual current device (RCD) or circuit breaker frequently trips.

Installation Notes

Important Notes

- Before installation, contact a local authorized installer. If the device is not installed by an authorized installer, the issue may not be covered under warranty for formal reasons.
- The air conditioner must be installed by an authorized installer – a service technician with an F-gas certificate, in accordance with national wiring regulations, flammable gas handling regulations, health and safety regulations, and this manual.
- A refrigerant leak test must be performed after installation.
- To move and reinstall the air conditioner in another location, contact a local authorized service center.

Checking the Contents

- Open the carton and check the air conditioner in a well-ventilated room (open the door and window) and away from any ignition sources. Note: Air conditioning technicians must wear anti-static equipment.
- Before opening the carton of the outdoor unit, the technician must check for any refrigerant leaks. If a leak is detected, the installation must be stopped.
- Firefighting equipment and anti-static precautions should be prepared before checking the contents. Then, check the refrigerant installation for any signs of damage and ensure the general appearance and condition of the installation are good.

Safety Rules for Air Conditioner Installation

- Fire protection measures should be prepared before installation.
- Continue the installation in a location with proper ventilation (open the door and window).
- No ignition sources should be near refrigerant R32; smoking and using mobile phones are prohibited.
- Anti-static precautions are necessary when installing the air conditioner, such as wearing clean cotton clothes and protective gloves.
- During installation, ensure the leak detector is operational.
- If a refrigerant R32 leak occurs during installation, immediately stop the operation, recover the refrigerant into a storage tank, check the tightness of the air conditioner's refrigerant circuit, and contact an authorized service center for assistance if the cause was a factory defect.
- Keep electrical devices, power switches, plugs, electrical outlets, high-temperature heat sources, or areas with high electrostaticity away from the area below the indoor unit.

Installation Notes

- The air conditioner should be installed in an easily accessible location for both installation and maintenance, without obstacles that may block the air inlets and outlets of the indoor/outdoor units, and should be kept away from heat sources, flammable or explosive materials.
- During the installation or repair of the air conditioner, if it is found that the refrigerant system has insufficient pipe diameter, the entire refrigerant connection piping system should be replaced with a new installation according to the original specifications. The use of reducing fittings to expand the pipe diameter is not allowed.
- After using a new connecting pipe, flare the ends again.

Installation Site Requirements

- Avoid locations prone to flammable or explosive gas leaks or strong aggressive gases.
- Avoid locations exposed to strong artificial electric/magnetic fields.
- Avoid locations exposed to noise and resonance.
- Avoid harsh natural conditions (e.g., soot, strong sandy-dusty winds, direct sunlight, or high-temperature heat sources).
- Avoid locations within reach of children.
- Shorten, if possible, the length of installation between the indoor and outdoor units.
- Choose a location that is easy for service and repair and where good ventilation is available.
- The outdoor unit must not be installed in a way that would obstruct passageways, stairways, exits, fire evacuation routes, or other public spaces.
- The outdoor unit should be installed as far as possible from neighbors' doors and windows, and away from plants.

Installation Environment Check

- Check the nameplate of the outdoor unit to ensure that the refrigerant R32 is used in the device.
- Check the room area. The space for the indoor unit should be no smaller than the usable area specified (5m²).
- The outdoor unit should be installed in a well-ventilated area.
- When using an electric drill to make holes in the wall, first check for any interference with water, sewage, electrical, or gas installations.
- It is recommended to use a specially made hole in the roof or create a passage through the wall for the installation of the air conditioner.

Installation Notes

Mounting Bracket Requirements

- The mounting bracket must meet relevant national or industrial standards in terms of strength, and welding and joint areas should be protected against corrosion.
- The mounting bracket and its load-bearing surface must withstand four times the weight of the device or 200kg, whichever is greater.
- The outdoor unit's mounting bracket should be fixed using expansion anchors.
- Ensure a secure installation regardless of the type of wall it is mounted on to prevent potential falls that could injure people.

Electrical Safety Requirements

- Use a dedicated circuit to power the air conditioner, and the cross-section of the power supply cable must meet national standards.
- If the air conditioner's maximum current is $\geq 16A$, an overcurrent circuit breaker and a residual current device (RCD) must be used. The use of an RCD does not eliminate the need for protection with an appropriate fuse.
- The operating voltage range of the air conditioner is 90%-110% of the local nominal voltage. Improper power supply poses a risk of electric shock or fire. If the power supply is highly unstable, a voltage regulator is recommended.
- The minimum distance between the air conditioner and flammable materials should be 1.5m.
- The connection cable links the indoor and outdoor units. The appropriate cable size must be selected before preparation for connection.
- The required cross-section of the power cable, communication cable, fuse, and overcurrent circuit breaker is determined by the device's maximum current, which is specified on the nameplate located on the device's side panel. Refer to the nameplate to select the proper cable, fuse, or overcurrent circuit breaker.
- Note: The number of cable cores corresponds to the specific wiring diagram attached to the casing of the purchased device.
- The power disconnect switch must be connected to a permanent power supply according to accepted standards.

Wall-Mounted Air Conditioners

RAC 09 - 12 - If cable to the outdoor unit	ODU 3x2,5mm ²	ODU-IDU Communication 5x1,5mm ²	Fuse S1 10A
RAC 09 - 12 - If cable to the indoor unit	IDU 3x2,5mm ²	ODU-IDU Communication 4x1,5mm ²	Fuse S1 10A
RAC 18 - 24 - If cable to the outdoor unit	ODU 3x2,5mm ²	ODU-IDU Communication 5x2,5mm ²	Fuse S1 16A
RAC 18 - 24 - If cable to the indoor unit	IDU 3x2,5mm ²	ODU-IDU Communication 4x2,5mm ²	Fuse S1 16A

Installation Notes

Height Work Requirements

- When installing at a height of 2 meters or more above the base level, wear safety harnesses and securely attach ropes to the outdoor unit to prevent falls, which can cause injury, death, or property damage.

Grounding Requirements

- The air conditioner is a Class 1 electrical device and must have reliable grounding.
- Do not connect the grounding wire to gas pipes, water pipes, lightning rods, telephone lines, or circuits poorly grounded to earth.
- The grounding wire is specifically designed and must not be used for other purposes or secured with ordinary threaded screws.
- The diameter of the connection wire should follow the recommended specifications in the user manual, and O-type terminals should fit the size of the screw on the device's electrical terminal block (no more than 4.2 mm).
- After installation, check that the screws are effectively tightened and there is no risk of wire loosening.

Other Requirements

- The connection method of the air conditioner and the power supply wire, as well as the connection of each individual component, must follow the electrical diagram attached to the device.
- The model of the device and the rated protection value must match the parameters specified for the appropriate circuit breaker or fuse sleeve.

Installation Notes

Content Check

Indoor Unit Packaging:

Name	Quantity	Unit
Indoor unit	1	set
Remote controller	1	piece
Batteries	2	piece
User manual	1	set
Condensate drain pipe	1	piece

Outdoor Unit Packaging:

Name	Quantity	Unit
Outdoor unit	1	set
Plastic tape	1	roll
Drain fitting	1	piece

Note: All accessories are subject to factory packaging and may vary depending on the production series.

Installation Notes for Coastal Areas

Installation Instructions for Coastal Areas

- Air conditioners should not be installed in locations with corrosive gases, such as acidic or alkaline gases.
- The unit must not be installed where it may be directly exposed to sea wind (containing salt), as this can cause product corrosion. Corrosion, particularly on the fins of the heat exchanger and evaporator, may lead to malfunction or inefficient operation.
- If the outdoor unit is installed near the sea, it should not be directly exposed to sea wind. Otherwise, additional anti-corrosion protection for the heat exchanger will be required.
- Choose a well-drained location for installing the outdoor unit.
- Selection of the outdoor unit location:
 - Install the outdoor unit on the side opposite to the sea wind direction or erect a protective barrier against sea wind. This will help protect the outdoor unit from adverse effects of sea wind.
 - The wind barrier should be strong enough to withstand sea wind. Its height and width should be at least 150% of the size of the outdoor unit. It is recommended to construct the barrier from concrete or other durable materials.
 - Maintain a distance of more than 70 cm between the outdoor unit and the wind barrier to allow free airflow.
 - Regular cleaning of the outdoor unit to remove dust or salt particles accumulated on the heat exchanger should be carried out with water and more frequently than once a year.

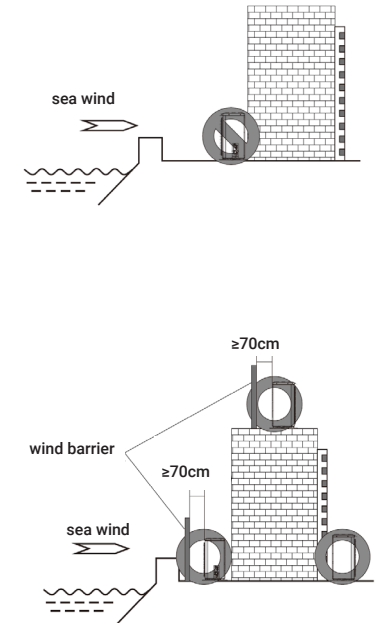

Installation of the indoor unit

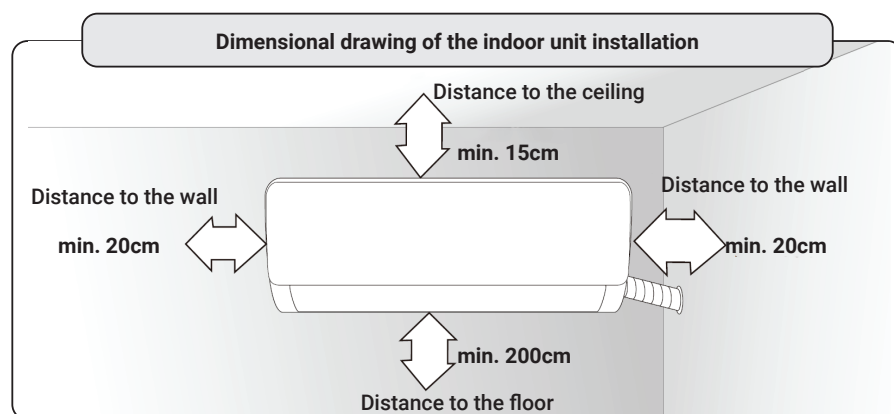

Mounting plate

- The wall for installing the indoor unit must be sufficiently hard and solid to prevent vibrations.
- Use a „+“ screw to attach the mounting plate, install it horizontally on the wall, and ensure it is aligned both horizontally and vertically.
- After installation, gently pull the suspended plate by hand to check if it is secure.

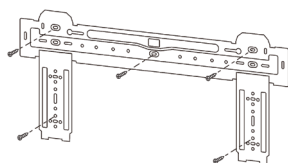

Hole through the wall

- Make a hole using an electric hammer or drill in the designated location on the wall for the pipes, which should be inclined outward by 5° - 10°.
- To protect the wires and cables from damage as they pass through the wall, and to prevent rodents that may be inside the hollow wall, install a sealing ring from the outside and seal the other side of the hole with sealant.

Note: Typically, the hole in the wall has a diameter of 60mm ~ 80mm. Be careful of the pre-installed power cable and reinforcement in the wall while making the hole.

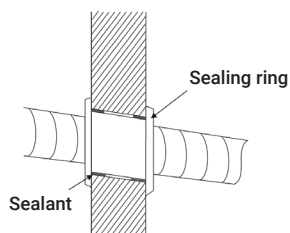

Installation of the indoor unit

Pipe routing

- Depending on the position of the unit, the piping can be routed from the left or right side (Fig. 1) or vertically from the rear (Fig. 2), depending on the length of the indoor unit's pipe. When routing sideways, remove the end caps from the device's housing on the appropriate side.

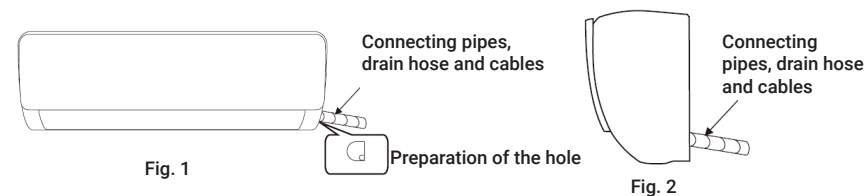

Connection of refrigerant pipes

- Depending on the position of the unit, the piping can be routed from the left or right side (Fig. 1) or vertically from the back (Fig. 2) (depending on the length of the indoor unit pipe). In the case of side routing, the caps of the housing exit on the appropriate side of the device should be cut off.

Torque tightening table

Pipe size (mm)	Torque (Nm)
6/6,35	15~25
9/9,52	35~40
12/12,7	45~60
15,88	73~78
19,05	75~80

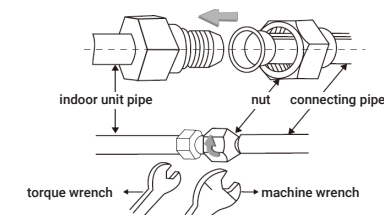

Mounting plate

- Use insulating tape to wrap the connecting part between the indoor unit and the connecting pipe, then use insulating material to wrap and seal the pipe to prevent condensation from forming on the connected surface.
- Connect the condensate outlet with drain pipes and make the connection of connecting pipes, cables, and drain hose.
- Use plastic cable ties to bundle the connecting pipes, cables, and drain hose. Route the condensate pipe with a downward slope.

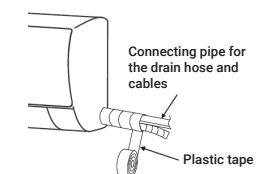

Installation of the indoor unit

Mounting the indoor unit

- Hang the indoor unit on the mounting plate and slide the unit from left to right to ensure that the hook is properly positioned on the mounting plate.
- Press towards the left bottom and top right sides of the unit towards the mounting plate until the hook clicks into place and makes a “click” sound.

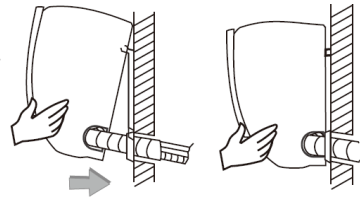

Electrical connection diagram

- If your air conditioner is equipped with a power cable, the wiring of the indoor unit is pre-connected, and no further connection is needed.
- If the power cable is not provided, connection is required according to the diagram.

After installation, check:

- Whether the screws are properly tightened and there is no risk of loosening.
- Whether the display plate connector is in the correct position and the wires do not touch the terminal strip.
- Whether the control box cover is tightly closed.

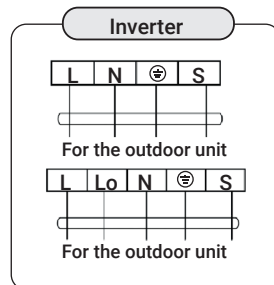

If there is a connector, connect it directly.

Note:

As a result of continuous product development, the manufacturer reserves the right to make changes to the technical documentation of the devices.

The diagram presented here is for reference only. If the unit does not match this diagram, please refer to the detailed electrical diagram provided on the purchased device.

Installation of the outdoor unit

Dimensional drawing of the external unit location

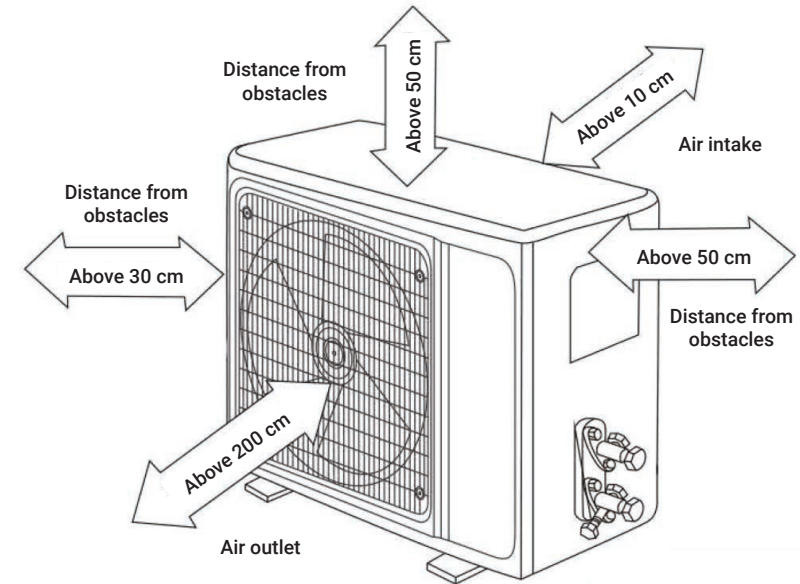

Connection Pipe Installation

- Connect the outdoor unit using the connecting pipe:
- Aim the connecting pipe at the control hole near the shut-off valve and tighten it with a torque wrench.
- When extending the pipes, an additional amount of refrigerant should be added to avoid compromising the operation and performance of the air conditioner.

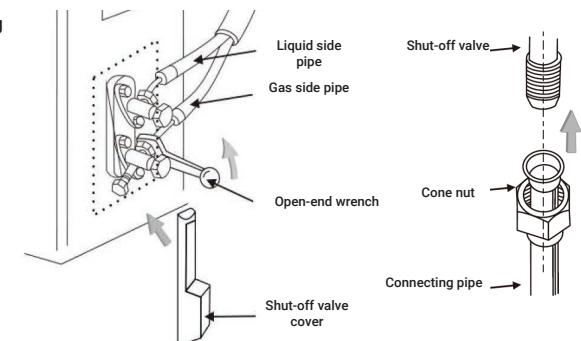

Installation of the outdoor unit

Pipe Length	Amount of refrigerant to be added		Amount of refrigerant for the unit
< 3M	CC ≤ 12000 Btu	subtract 20g/m	≤ 1kg
	CC ≥ 18000 Btu	subtract 40g/m	≤ 2kg
3 - 5M	Not needed		
5 - 15M	CC ≤ 12000 Btu	add 16g/m	≤ 1kg
	CC ≥ 18000 Btu	add 24g/m	≤ 2kg

Note: This table is for reference only. Fittings cannot be reused unless the pipe is re-soldered. After installation, check the shut-off valve cover to ensure it is securely mounted.

Wiring Connection

- Loosen the screws and remove the E-part cover from the device.
- Connect the power wires to the appropriate terminal blocks of the outdoor unit (refer to the electrical diagram), and make the communication wire connections by simply connecting the contacts and tightening the screws securely.
- Grounding wire: Unscrew the grounding screw from the marked electrical terminal, attach the grounding wire terminal to the screw, and screw it into the grounding hole.
- Secure the wire firmly and permanently using mounting components.
- Reinstall the E-part cover to its original position and secure it with screws.

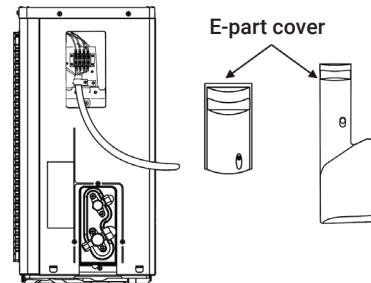

Wiring Connection

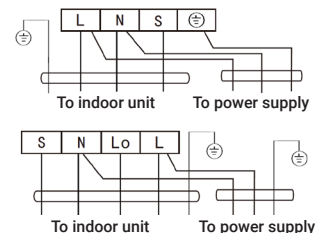

Connector
If there is a connector, connect it directly.

Note: As a result of continuous product development, the manufacturer reserves the right to make changes to the technical documentation of the devices. The diagram presented here is for reference only. If the unit does not match this diagram, refer to the detailed electrical diagram provided with the purchased device.

Installation of the outdoor unit

Vacuum Creation

To create a vacuum in an R32 refrigeration system, only a vacuum pump designed for R32 refrigerant should be used.

Before starting work with the air conditioner, remove the shutoff valve cover (gas and liquid valves) and remember to tighten it later.

- To prevent refrigerant leaks, tighten all nut connections of the flare fittings on all pipes.
- Connect the shutoff valve, service hose, manifold gauge, and vacuum pump.
- Fully open the Lo knob on the manifold gauge and create a vacuum for at least 15 minutes. Check the pressure gauge to ensure the vacuum value in the system is -0.1 MPa (-76 cmHg).
- After completing the vacuum process, fully open the shutoff valves on the gas and liquid lines using a hex wrench.
- Check if the internal and external connections are free from refrigerant leaks.

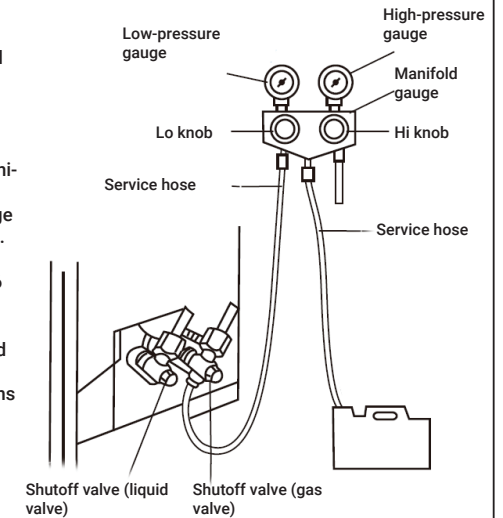

External condensate drain (heat pump type only)

When the unit operates in heating mode, condensation water and water from the defrosting process can be reliably drained through the condensate drain installation.

Installation:

Install the external drain elbow in the 25mm hole on the base plate and connect the drain hose to the elbow so that the condensate produced in the outdoor unit is properly drained to the designated location.

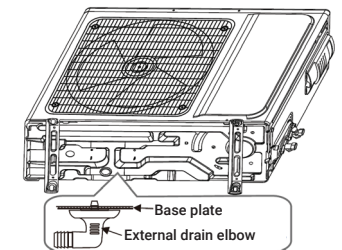

Post-installation verification and functionality test

Check after installation

Electrical safety inspection:

- Is the power supply voltage compliant with the requirements?
- Are there any faulty or missing connections in any of the power, communication, or grounding wires?
- Is the grounding wire of the air conditioner properly grounded?

Installation safety inspection:

- Is the installation safe?
- Is the condensate drainage functioning properly?
- Is the wiring and piping properly installed?
- Check that there are no foreign objects or tools inside the unit.
- Check that the refrigerant piping is properly secured.

Refrigerant leak test:

Depending on the installation method, the following methods can be used to check for suspected leaks at areas such as the four connections of the outdoor unit and the cores of shut-off valves and service valves:

- Bubble method: Apply a soap solution evenly to the suspected leak point and carefully observe if any bubbles appear on the surface.
- Instrumental method: Check for leaks by directing the leak detector probe according to the instructions at suspected leak points.

Note: Before checking, ensure that the room has proper ventilation.

Operation Test

Preparation for the operation test:

- Check that all piping and connection cables are properly connected.
- Confirm that the gas and liquid side valves are fully open.
- Connect the power cable to an independent electrical outlet.
- Install batteries in the remote control.

Note: Ensure proper ventilation before starting the test.

Operation test:

- Turn on the power and press the ON/OFF button on the remote control to start the air conditioner.
- Select COOLING, HEATING, SWING, and other modes using the remote control and check if the operation is correct.

Maintenance Guidelines

CAUTION !

Both for maintenance or disposal of the unit, you should contact authorized service centers. Performing work by an unqualified person may pose a risk. Do you have an air conditioner with refrigerant R32? Maintain it according to the manufacturer's requirements. This section primarily focuses on special maintenance requirements for units with R32 refrigerant. Ask the service technician to read the technical service manual for detailed information.

Qualifications for technical personnel

- Special additional training, beyond standard refrigeration equipment repair procedures, is required when dealing with flammable refrigerants. In many countries, this training is provided by national training organizations accredited to teach the relevant subjects. The achieved competencies should be documented with a certificate.
- Maintenance and repair of the air conditioner must be carried out according to the method recommended by the manufacturer. If personnel from other specialties are needed to assist with the maintenance and repair of the equipment, it should be done under the supervision of individuals qualified to repair air conditioners equipped with flammable refrigerants.

On-site inspection:

Before servicing the device with R32 refrigerant, a safety inspection must be conducted to minimize the risk of fire. Ensure that the area is well-ventilated and that appropriate antistatic and fire protection equipment is in place. During technical work carried out on the refrigeration system, the following safety precautions should be followed.

Operational Procedures

- General Work Area: All technical service personnel and others working in the area should be informed about the type of work being carried out. Avoid working in closed rooms. The area around the work zone should be isolated. Ensure that the working conditions are safe by checking for flammable materials.
- Checking for Refrigerant Presence: The area should be checked using an appropriate R32 refrigerant detector during work to ensure that the technician is aware of any potentially toxic or flammable atmosphere. Ensure that the leak detection device used is suitable for use with all types of refrigerants, specifically those classified as non-sparking, properly sealed, or explosion-proof.
- Presence of Fire Extinguisher: In case soldering or cutting work is required on the refrigeration system or its components, appropriate fire-fighting equipment must be available. Place a powder or CO2 fire extinguisher next to the location where refrigerant is being charged into the system.

Maintenance Guidelines

- **No Ignition Sources:** No one working with a refrigeration system that requires intervention should use any ignition sources in a way that could pose a fire or explosion hazard. All potential ignition sources, including smoking, should be kept far enough away from the installation, repair, transport, and disposal areas where refrigerant may be released into the surrounding space. Before working in the area, inspect the surroundings of the device to ensure there are no flammable hazards or ignition risks. Smoking bans should be posted.
- **Ventilated Area (open doors and windows):** Ensure that the work area is outdoors or properly ventilated before intervening in the system or performing any heat-generating tasks such as soldering or cutting. The ventilation should be maintained throughout the work period. The ventilation should safely disperse any refrigerant that may be accidentally released, venting it safely outside the atmosphere.
- **Refrigeration Equipment Checks:** When replacing electrical components, they should match the intended purpose and meet the correct specifications. Always follow the manufacturer's guidelines for maintenance and servicing. If in doubt, contact the manufacturer's technical department for assistance. For systems using flammable refrigerants, the following checks should be performed:
 - The amount of refrigerant in the system should be in accordance with the size of the room where refrigerant-containing components are installed.
 - Ventilation devices and air outlets should be functioning correctly and not blocked.
 - If an intermediate cooling circuit is used, the secondary circuit must be checked for refrigerant presence.
 - Pipes or refrigeration components should be installed in locations unlikely to be exposed to substances that could corrode refrigerant-containing components unless the components are made of materials that are naturally corrosion-resistant or adequately protected against corrosion.
- **Electrical Equipment Checks:** Repair and maintenance of electrical components involve initial safety checks and procedures for inspecting parts. If a fault occurs that could jeopardize safety, the electrical supply should not be connected to the circuit until the issue is resolved in an acceptable manner. If the error cannot be corrected immediately but work must continue, appropriate temporary measures should be taken. This should be reported to the equipment owner to inform all involved parties. Initial safety checks include:
 - Check whether capacitors are discharged: this should be done safely to prevent sparking.
 - No electrical components or wiring should be exposed during recharging, refrigerant recovery, or blowing out the refrigeration system.
 - Maintain grounding continuity.

Cable Inspection

Check the cables for wear, corrosion, surges, vibrations, and inspect the surrounding environment for sharp edges and other undesirable effects. During the inspection, consider the impact of aging or continuous vibrations from the compressor and fan on the cables.

Maintenance Guidelines

Refrigerant Leak Detection for R32

Note: Check for refrigerant leaks in an environment without any potential ignition sources. Do not use a halogen probe (or any other detector with an open flame).

Leak Detection Method:

- For systems using R32 refrigerant, an electronic leak detector is recommended for leak detection, and this should not be done in an area where refrigerant has been released. Ensure the detector does not become a potential ignition source and is suitable for the refrigerant being measured. The leak detector should be set to detect the minimum concentration (percentage) of the refrigerant. Calibrate and adjust the detector for the appropriate gas concentration (not exceeding 25%) using the refrigerant in use.
- The fluid used for leak detection is suitable for most refrigerants, but do not use chlorinated solvents to prevent reactions between chlorine and refrigerants, which can lead to corrosion of copper piping. If a leak is suspected, remove all potential fire sources from the area at risk of fire. If the leak location requires soldering, recover the entire refrigerant charge or isolate the refrigerant from the leak area (using a shut-off valve). Before and during soldering, use nitrogen to purge the entire system.

Refrigerant Recovery and Vacuum Pumping

1. Ensure there are no ignition sources near the vacuum pump exhaust, and that ventilation is effective.
2. Allow maintenance and other refrigeration circuit operations to proceed according to the general procedure, but focus on the following key operations where flammability must be considered:
 - Recover the refrigerant.
 - Purge the pipework with an inert gas—nitrogen.
 - Perform vacuum pumping.
 - Purge the pipework again with inert gas—nitrogen.
 - Cut or solder the refrigeration system.
3. The refrigerant must be recovered into an appropriate storage tank. For safety, the system should be purged with nitrogen. This process may need to be repeated multiple times. This operation should not be performed with compressed air or oxygen. By purging with nitrogen, the system is deprived of oxygen, followed by a pressure test to reach the operating pressure before vacuum pumping is performed. Then, nitrogen is released into the atmosphere, and finally, a vacuum is achieved in the system. Repeat this process until the refrigerant is fully removed from the system, and the installation can be considered clean. After the final nitrogen filling, reduce the nitrogen pressure to atmospheric levels, and then solder the system components. This operation is essential for proper system soldering.

Maintenance Guidelines

Refrigerant Charging Procedures

In addition to the general procedure, the following requirements should be added:

- Ensure that there are no contaminants between different types of refrigerants when using equipment for refrigerant charging and recovery. The hoses used for refrigerant charging should be as short as possible to minimize residual amounts of refrigerant.
- Accumulation tanks should remain in an upright position.
- Ensure that grounding has been completed before the refrigerant is charged into the system.
- After charging is complete, label the device with the appropriate information regarding the system's charge.
- Take care not to overcharge the system with refrigerant.

Disposal and Recovery

Disposal:

Before this procedure, the technical personnel should thoroughly familiarize themselves with the equipment and its features and recommend a safe refrigerant recovery technique. Before beginning the recycling of the refrigerant, the refrigerant and oil samples should be analyzed. Ensure the required power supply is available before the test.

1. Familiarize yourself with the equipment and operation.
2. Disconnect the power supply.
3. Before performing this process, ensure that:
 - If necessary, mechanical equipment should be used to facilitate the refrigerant recovery process.
 - All personal protective equipment is effective and can be properly applied.
 - The entire recovery process should be conducted under the supervision of qualified personnel.
 - The recovery of equipment and refrigerant should comply with applicable national standards and regulations.
4. If possible, the cooling system should be evacuated.
5. If vacuuming is not achievable, refrigerant should be extracted from each part of the system from multiple points.
6. Before starting the recovery, ensure the recovery tank has sufficient capacity.
7. Operate the recovery equipment according to the manufacturer's instructions.
8. Do not fill the tank to full capacity (the volume of recovered liquid should not exceed 80% of the tank's capacity).
9. Even for a short time, do not exceed the maximum operating pressure of the tank.
10. After filling the tank and completing the process, ensure that both the accumulation tanks and equipment are cleaned quickly, and all shut-off valves on the device are closed.
11. Recovered refrigerant cannot be introduced into another system before it has been cleaned and tested.

Note: Proper identification information should be placed after the device is scrapped and after the refrigerant has been recovered. The identification should include the date and confirmation of the operation. Ensure that the identification data on the device can indicate the presence of flammable refrigerants in the equipment.

Maintenance Guidelines

Recovery:

Refrigerant Recovery During Repair or Scrapping

- During the repair or scrapping of the equipment, refrigerant recovery in the system is required. It is recommended to completely remove the refrigerant.

Recovery Storage Tank

- Only a special refrigerant recovery tank, suitable for the refrigerant, should be used as the storage tank. Ensure that the tank capacity is appropriate for the amount of refrigerant in the entire system. All tanks intended for refrigerant recovery should be labeled with the refrigerant type (i.e., refrigerant recovery tank). Recovery tanks should be equipped with pressure-limiting valves and shut-off valves and should be in good condition. If possible, empty tanks should be emptied and stored at room temperature before reuse.

Recovery Equipment Maintenance

- The recovery equipment should be kept in good working condition and equipped with an easily accessible operating manual. The equipment should be suitable for recovering R32 refrigerant. A legalized scale for weighing, which is suitable for normal use, should also be applied. The service hose should be connected to a detachable connector with zero leakage speed and kept in good working order. Before using recovery equipment, ensure it is in good condition and properly maintained. Check if electrical components are sealed to prevent refrigerant leakage and possible fire hazards. If you have any questions or concerns, contact the manufacturer.

Refrigerant Refill and Return

- The recovered refrigerant should be filled into appropriate recovery tanks, with transport instructions attached, and returned to the refrigerant manufacturer. Do not mix refrigerants in recovery equipment, especially in the tank.

Transporting Refrigerant

- The transport compartment must not be fully sealed during the transportation of R32 refrigerant. If necessary, take anti-electrostatic protection measures during transport. During transport, loading, and unloading, necessary precautions should be taken to protect the air conditioner to ensure it is not damaged.

Compressor Oil and Refrigerant Removal

- When removing the compressor or recovering compressor oil, ensure the compressor is emptied to an appropriate level to ensure there is no residual R32 refrigerant in the compressor oil. The vacuum pumping should be done before returning the compressor to the supplier. Ensure safety when removing oil from the system.

Instructions for Connecting to the App

To download the instructions for connecting the air conditioner to the app via Wi-Fi, as well as the app, scan the QR code below.



Scan to download the instructions for connecting the air conditioner to the app via Wi-Fi.



Scan to download the AC Freedom app for Android devices.



Scan to download the AC Freedom app for iOS devices.

Instructions for the Remote Control

To download the instructions for the remote control, scan the QR code below.

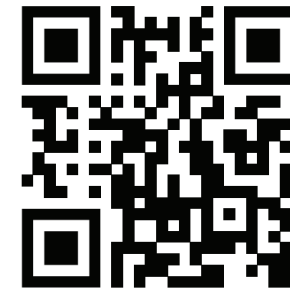

TYPE-C

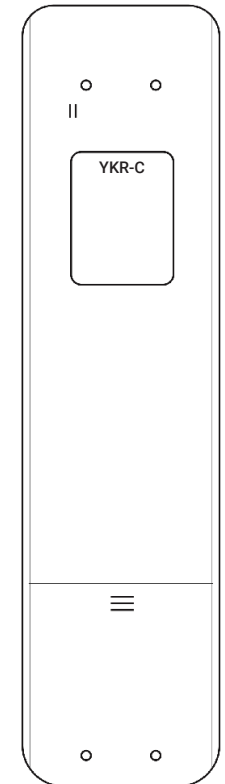

The model of the remote control is described on the back of the remote.

The devices contain fluorinated greenhouse gases R32 (HFC-32) with a GWP of 675.

Model	Refrigerant	Environmental indicators		Refrigerant quantity	
		GWP	ODP		
AUX-09CAA/O	R32	675	0	0,55kg	0,37 ton eq CO2
AUX-09CA/O	R32	675	0	0,55kg	0,37 ton eq CO2
AUX-12CAA/O	R32	675	0	0,60kg	0,41 ton eq CO2
AUX-12CA/O	R32	675	0	0,60kg	0,41 ton eq CO2
AUX-18CA/O	R32	675	0	1,03kg	0,70 ton eq CO2
AUX-24CA/O	R32	675	0	1,20kg	0,81 ton eq CO2

The importer of **AUX** devices

WIENKRA Sp. z o. o.

www.wienkra.pl

Sales offices:

Cracow Branch:

📍 31-539 Kraków, ul. Kotlarska 34

✉ wienkra@wienkra.pl

Warsaw-Janki Branch:

📍 05-090 Janki ul. Sokotowska 15

✉ wienkra-waw@wienkra.pl

Wrocław Branch:

📍 50-541 Wrocław, Al. Armii Krajowej 61

✉ wienkra-wro@wienkra.pl

Manufacturer:

NINGBO AUX ELECTRIC CO., LTD.

Address: No.1166 North Mingguang Road, Jiangshan Town, Ningbo, Zhejiang, P.R. China

Web: <http://www.cnaux.com>